

ACCESSIBILITY DETAILS FOR DOORS, MANEUVERING SPACES & ROUTES

UNLESS SPECIFICALLY STATED OTHERWISE, FIGURES ARE PROVIDED FOR INFORMATIONAL PURPOSES ONLY. (11B-104.3 FIGURES)

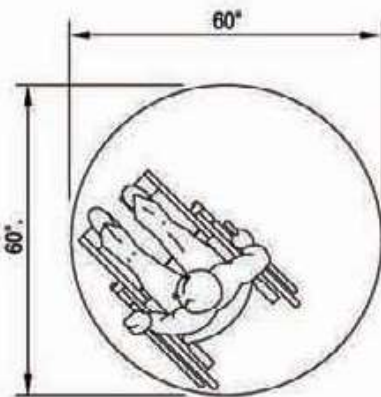

(a) 60 INCHES DIAMETER SPACE

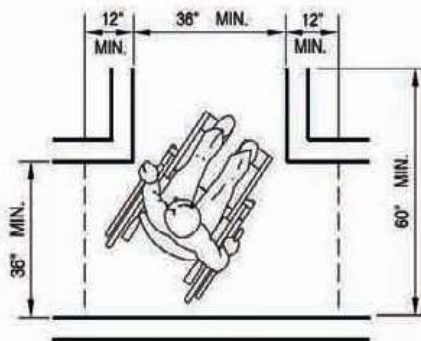

(b) T-SHAPED SPACE FOR 180° TURNS

Convention	Description
36 914	dimension showing English units (in inches unless otherwise specified) above the line and SI units (in millimeters unless otherwise specified) below the line
6 152	dimension for small measurements
33-36 838-914	dimension showing a range with minimum - maximum
min	minimum
max	maximum
>	greater than
≥	greater than or equal to
<	less than
≤	less than or equal to
---	boundary of clear floor space or maneuvering clearance
---○---	centerline
---	a permitted element or its extension
→	direction of travel or approach
— —	a wall, floor, ceiling or other element cut in section or plan
▒	a highlighted element in elevation or plan
▨	location zone of element, control or feature

**FIGURE 11B-104
 GRAPHIC CONVENTION
 FOR FIGURES**

**WHEELCHAIR
 TURNING SPACE**

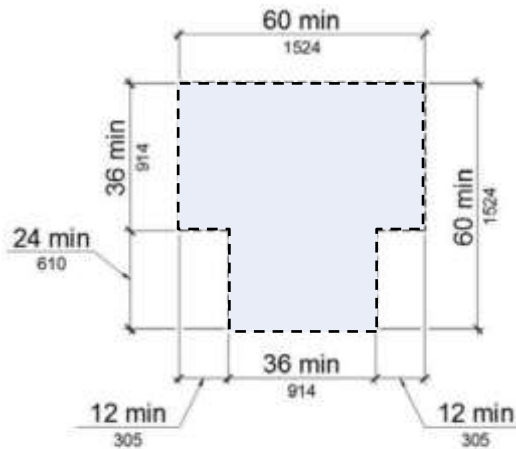

**FIGURE 11B-304.3.2
 T-SHAPED TURNING SPACE**

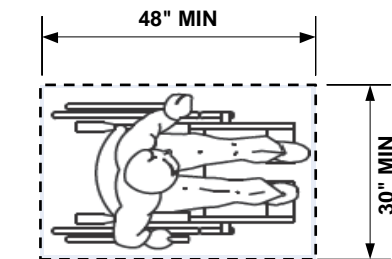

**FIGURE 11B-305.3
 CLEAR FLOOR OR GROUND SPACE**

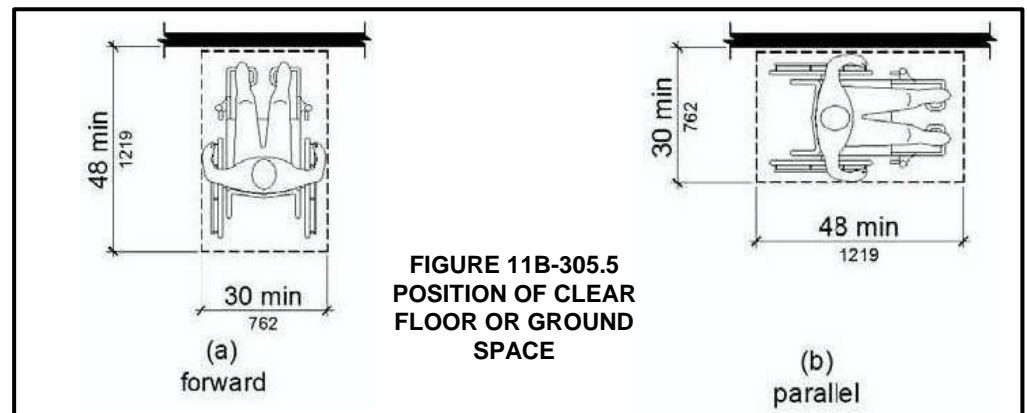

**FIGURE 11B-305.5
 POSITION OF CLEAR
 FLOOR OR GROUND
 SPACE**

THESE DIAGRAMS ILLUSTRATE THE SPECIFIC REQUIREMENTS OF THESE REGULATIONS AND ARE INTENDED ONLY AS AN AID FOR BUILDING DESIGN AND CONSTRUCTION.

DOORS & MANEUVERING SPACE

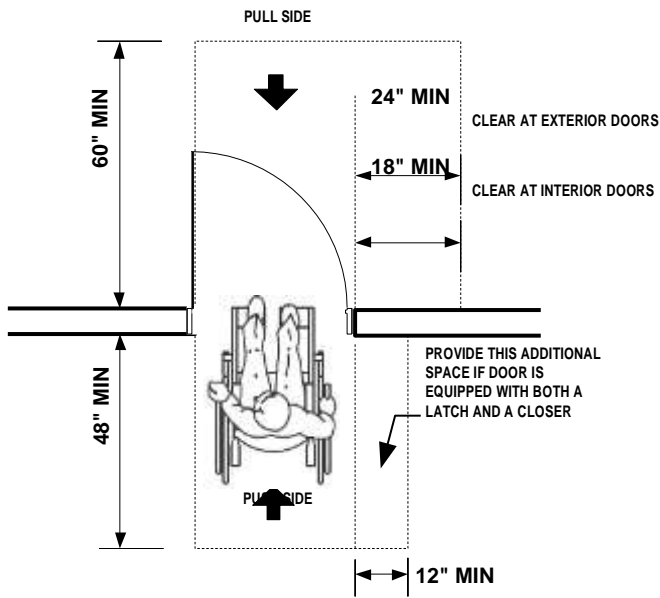

FRONT APPROACH

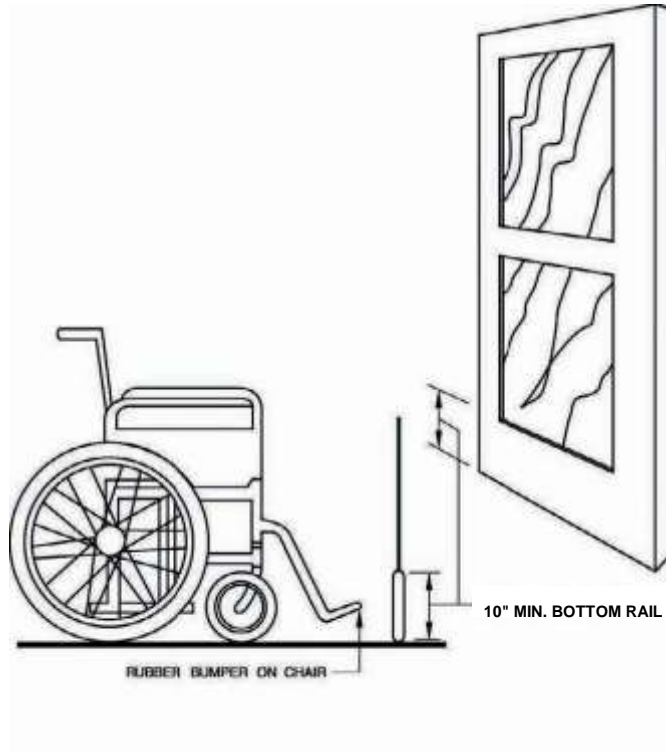

DOOR CONSTRUCTION

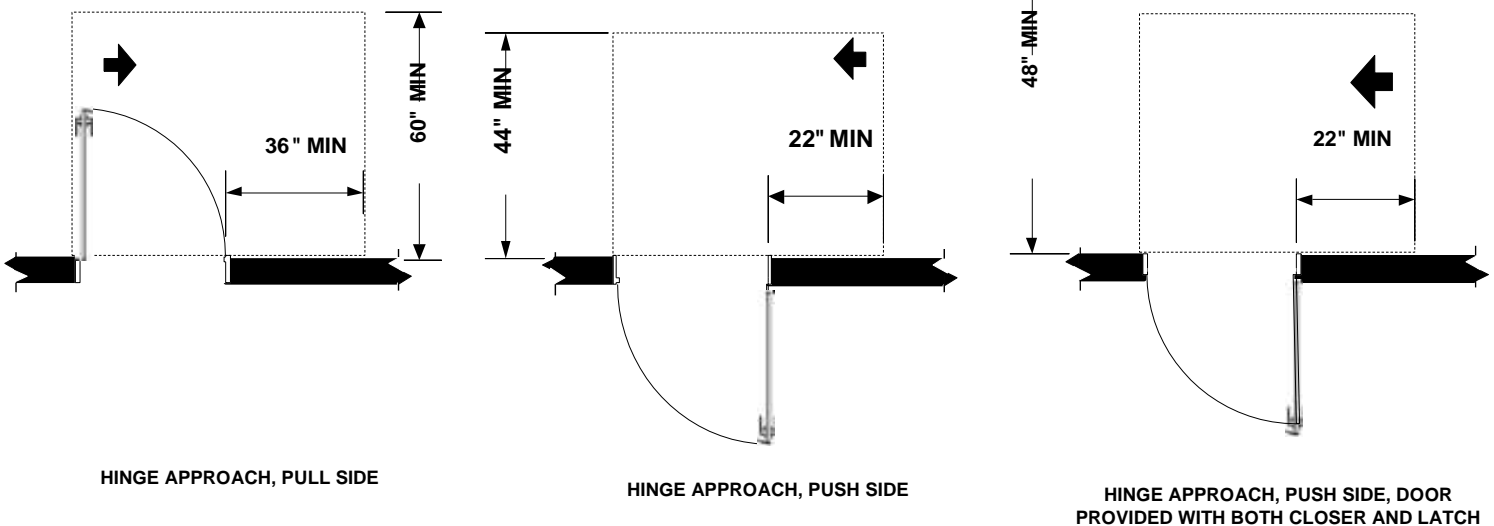

**FIGURE 11B-404.2.4.1
 MANEUVERING CLEARANCES AT MANUAL SWINGING DOORS AND GATES**

DOORS & MANEUVERING SPACE

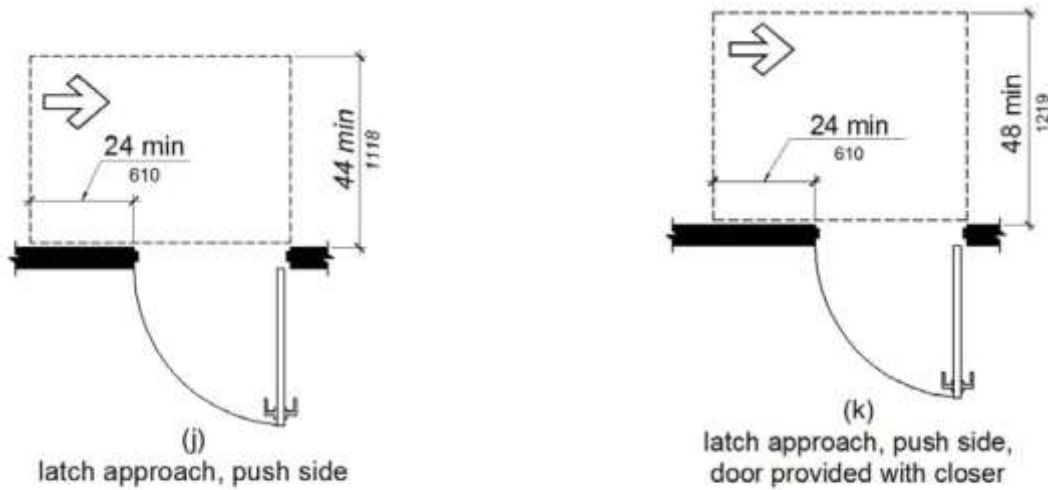

FIGURE 11B-404.2.4.1—continued
 MANEUVERING CLEARANCES AT MANUAL SWINGING DOORS AND GATES

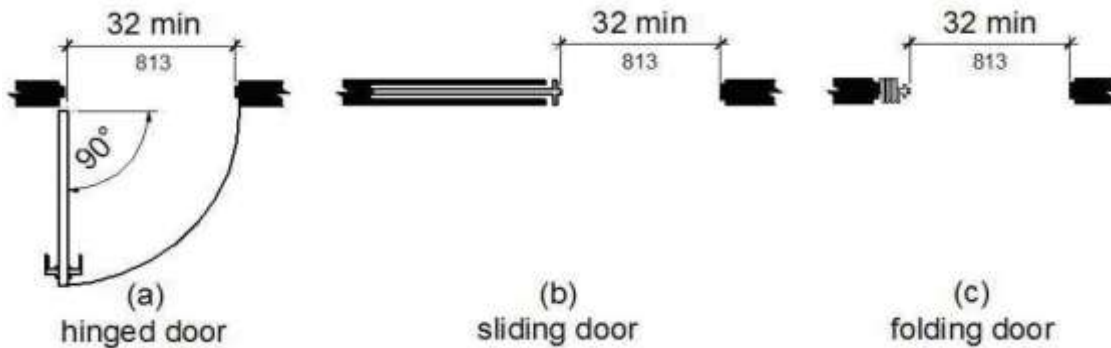

FIGURE 11B-404.2.3
 CLEAR WIDTH OF DOORWAYS

TABLE 11B-404.2.4.1
 MANEUVERING CLEARANCES AT MANUAL SWINGING DOORS AND GATES

TYPE OF USE		MINIMUM MANEUVERING CLEARANCE	
APPROACH DIRECTION	DOOR or GATE SIDE	PERPENDICULAR TO DOORWAY	PARALLEL TO DOORWAY (beyond latch side unless noted)
From front	Pull	60 inches	18 inches ⁵
From front	Push	48 inches	0 inches ¹
From hinge side	Pull	60 inches	36 inches
From hinge side	Push	44 inches	22 inches ³
From latch side	Pull	60 inches	24 inches
From latch side	Push	44 inches	24 inches

1. ADD 12 INCHES IF CLOSER AND LATCH ARE PROVIDED.
2. ADD 4 INCHES IF CLOSER AND LATCH ARE PROVIDED.
3. BEYOND HINGE SIDE.
4. ADD 4 INCHES IF CLOSER IS PROVIDED.
5. ADD 6 INCHES AT EXTERIOR SIDE OF EXTERIOR DOORS.

DOORS & MANEUVERING SPACE

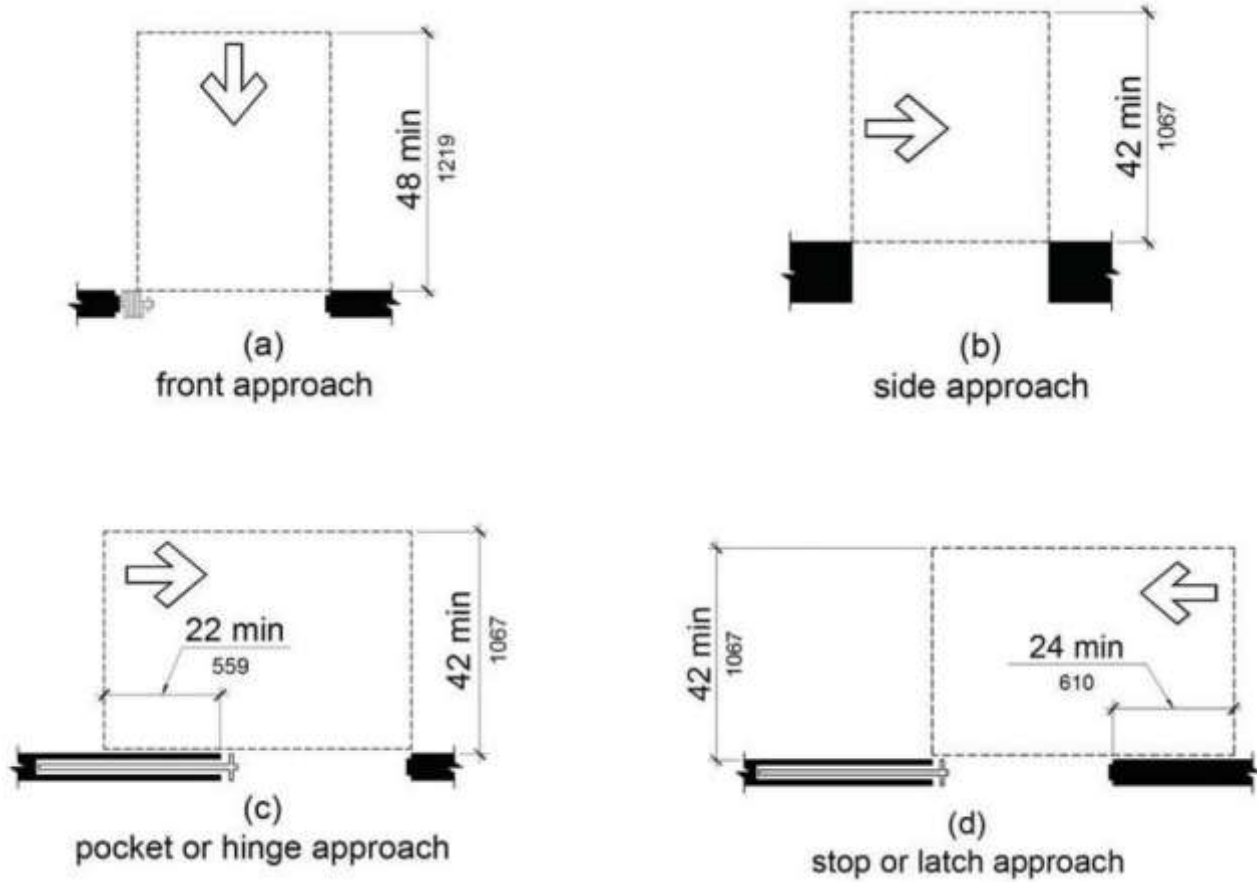

**FIGURE 11B-404.2.4.2
 MANEUVERING CLEARANCES AT DOORWAYS WITHOUT DOORS, SLIDING DOORS,
 GATES, AND FOLDING DOORS**

**TABLE 11B-404.2.4.2
 MANEUVERING CLEARANCES AT DOORWAYS WITHOUT DOORS OR GATES
 MANUAL SLIDING DOORS AND MANUAL FOLDING DOORS**

Approach direction	MINIMUM MANEUVERING CLEARANCE	
	Perpendicular to doorway	Parallel to doorway (beyond stop/latch side unless noted)
From Front	48 inches	0 inches
From Side ¹	42 inches	0 inches
From pocket/hinge side	42 inches	22 inches
From stop/latch side	42 inches	24 inches

- 1. Doorway with no door only.
- 2. Beyond pocket/hinge side

THESE DIAGRAMS ILLUSTRATE THE SPECIFIC REQUIREMENTS OF THESE REGULATIONS AND ARE INTENDED ONLY AS AN AID FOR BUILDING DESIGN AND CONSTRUCTION.

DOORS & MANEUVERING SPACE

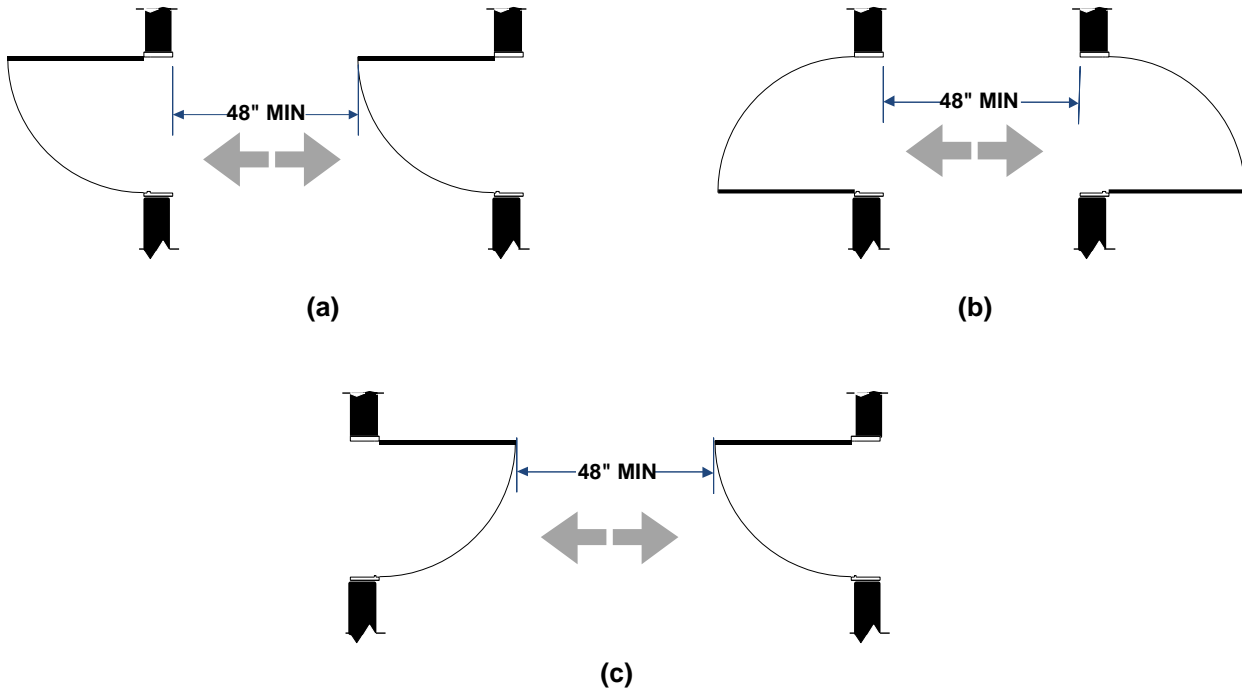
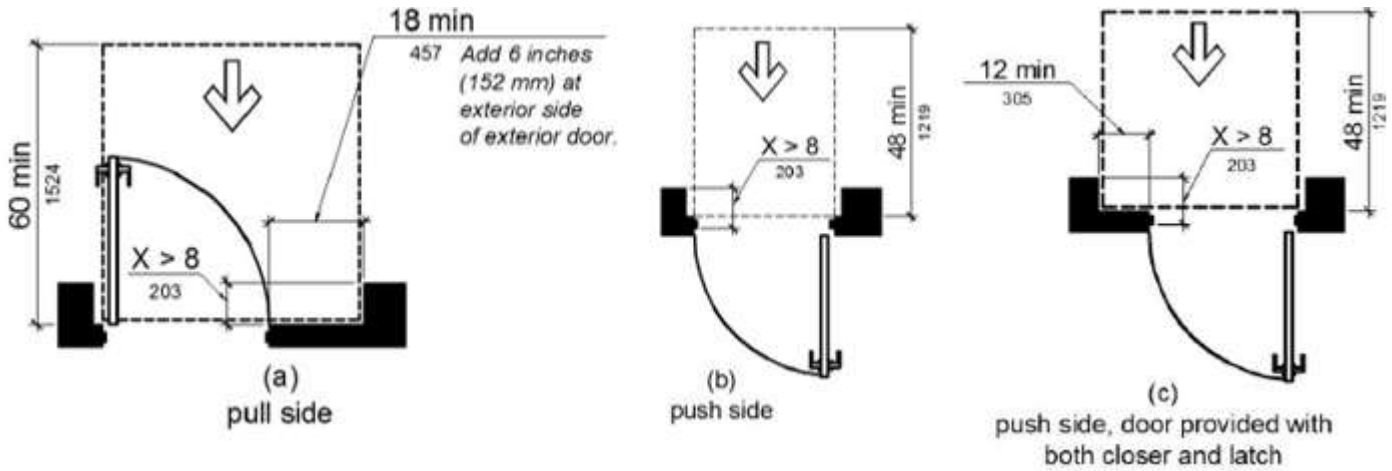

**FIGURE 11B-404.2.6
 DOORS IN SERIES AND GATES IN SERIES**

ACCESSIBLE ROUTES

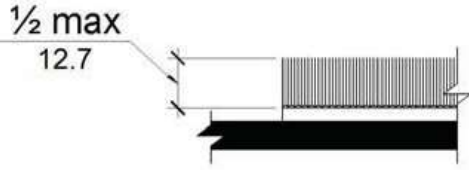
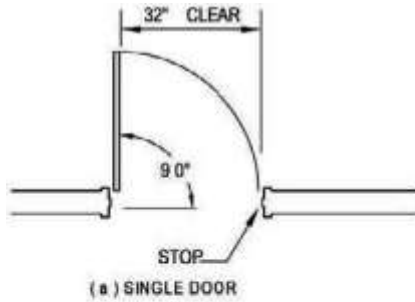

FIGURE 11B-302.2
 CARPET PILE HEIGHT



11B-404.2.3

Door openings shall provide a clear width of 32 inches minimum. Clear openings of doorways with swinging doors shall be measured between the face of the door and the stop, with the door open 90 degrees. Openings more than 24 inches deep shall provide a clear opening of 36 inches minimum. There shall be no projections into the required clear opening width lower than 34 inches above the finish floor or ground. Projections into the clear opening width between 34 inches and 80 inches above the finish floor or ground shall not exceed 4 inches.

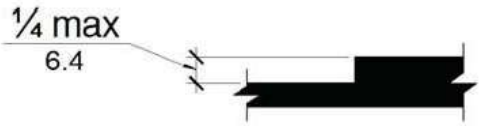
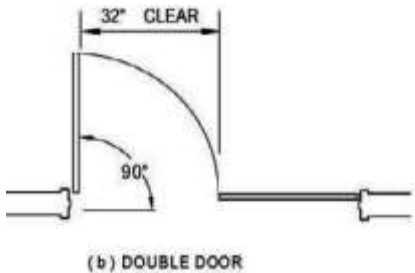

FIGURE 11B-303.2
 VERTICAL CHANGE IN LEVEL

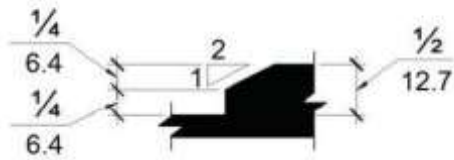
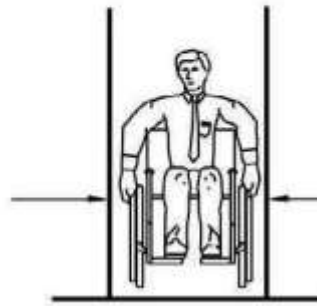
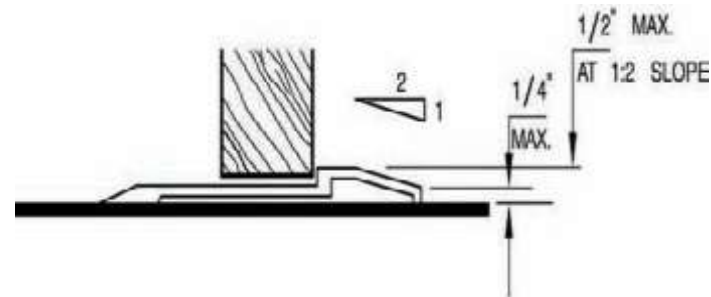

FIGURE 11B-303.3
 BEVELED CHANGE IN LEVEL



AN ADULT SIZE WHEELCHAIR AVERAGES 27 INCHES IN WIDTH. THE REQUIRED 32 INCH CLEAR OPENING ALLOWS 2-1/2 INCHES ON EACH SIDE FOR HANDS.



11B-404.2.5
 THRESHOLDS, IF PROVIDED AT DOORWAYS, SHALL BE 1/2 INCH HIGH MAXIMUM. RAISED THRESHOLDS AND CHANGES IN LEVEL AT DOORWAYS SHALL COMPLY WITH SECTIONS 11B-302 AND 11B-303.

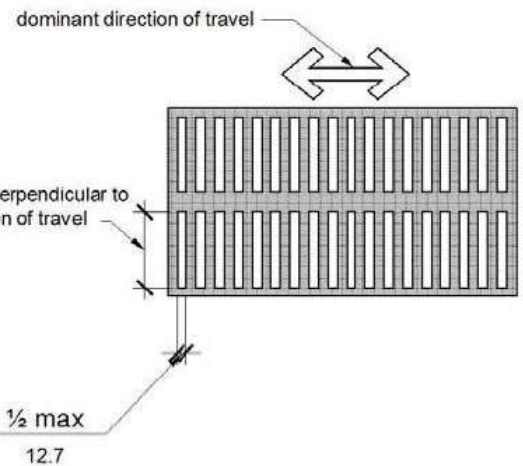
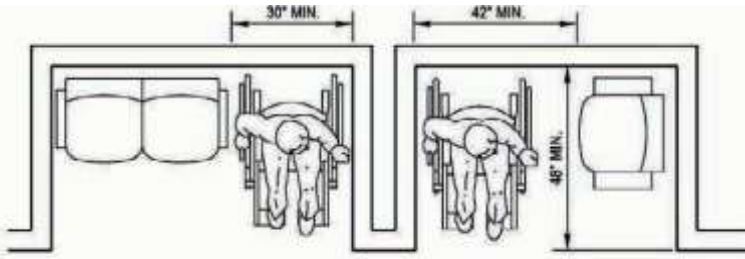

FIGURE 11B-302.3
 ELONGATED OPENINGS IN FLOOR OR GROUND SURFACES

THESE DIAGRAMS ILLUSTRATE THE SPECIFIC REQUIREMENTS OF THESE REGULATIONS AND ARE INTENDED ONLY AS AN AID FOR BUILDING DESIGN AND CONSTRUCTION.

ACCESSIBLE ROUTES



← ACCESSIBLE ROUTE OF TRAVEL →

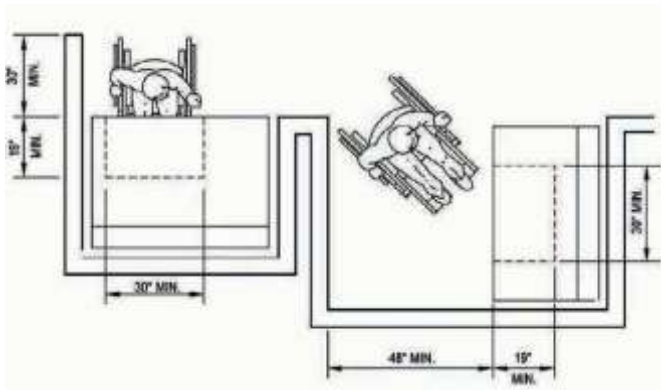

11B-403.5.1
SEE CLEAR WIDTH AND EXCEPTIONS
REQUIREMENTS

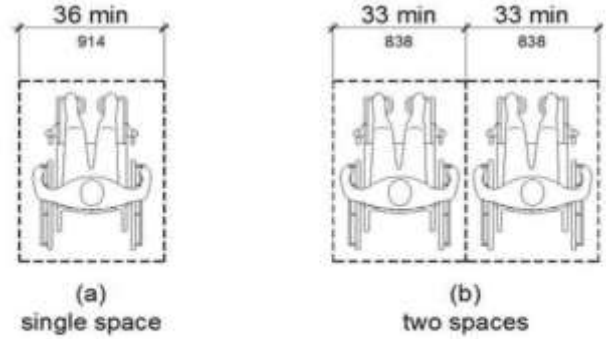

FIGURE 11B-802.1.2
WIDTH OF WHEELCHAIR SPACES

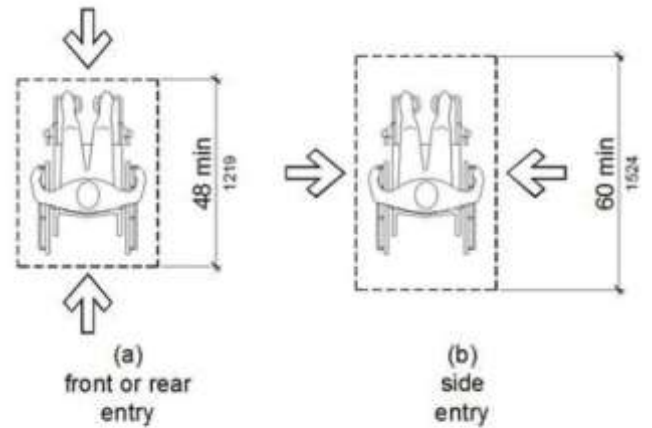

FIGURE 11B-802.1.3
DEPTH OF WHEELCHAIR SPACES

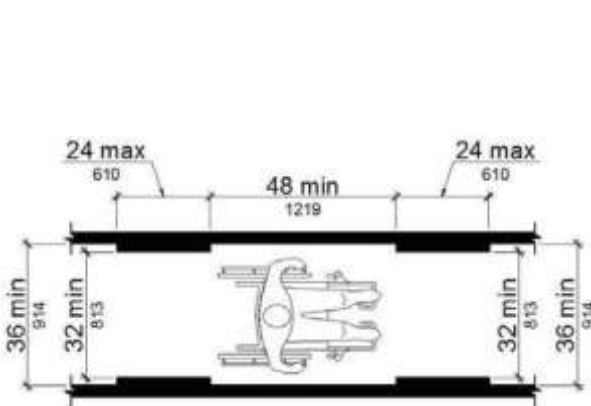

FIGURE 11B-403.5.1
CLEAR WIDTH OF AN ACCESSIBLE ROUTE

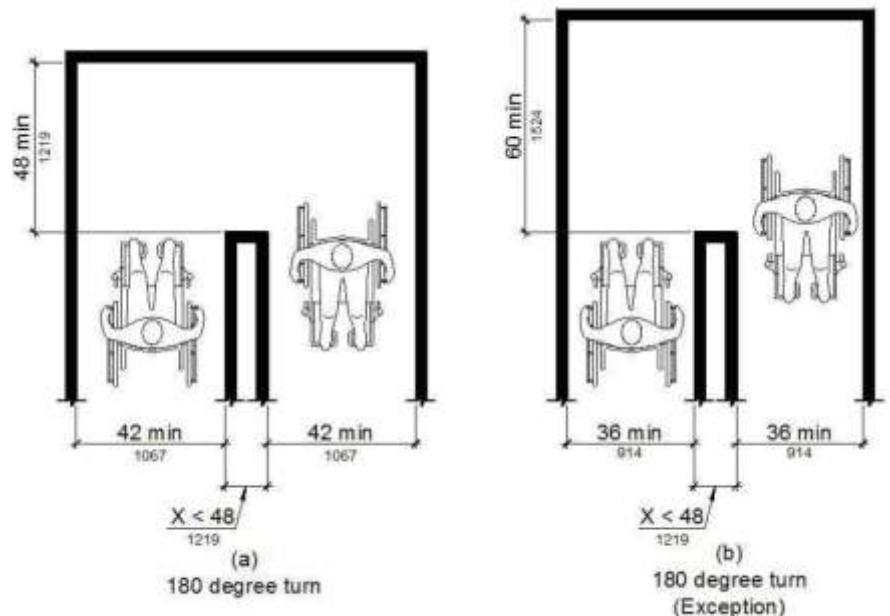

FIGURE 11B-403.5.2
CLEAR WIDTH AT TURN

As a covered entity under Title II of the Americans with Disabilities Act, the City of Los Angeles does not discriminate on the basis of disability and, upon request, will provide reasonable accommodation to ensure equal access to its programs, services and activities.